

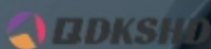

CATALOG



Company Introduction

The KSHD brand started in QINGDAO, China in 2008, specializing in the R&D, manufacturing and sales of urban furnitures. The factory has more than 15 years of successful management and production experience, and its products are exported to more than 80 countries and regions home and abroad, especially to Spain, UK, Europe, America and Australia. The main business refers to manufacturer and sale for bollards, benches, bike racks, litter bins, outdoor tables & chairs, bicycle stands, tree grates, trailer accessories and other outdoor furniture and customize products made of galvanized steel, 304 and 316. The company has established a fully automatic robot production line and a line of thermoplastic coating process, with an annual output of 130,000 pieces. Having the machines and producing line for welding, bending, laser coating and others.

KSHD has many years of manufacturing history and brand accumulation, and is committed to the accumulation of technology and talents. Transforming new technologies into productivity is the core competitiveness. It has invented dozens of utility model patents and design patents; passed the quality management system certification, environmental protection Management system certification, occupational health and safety management system certification, five star green supply chain management system certification and other certifications; KSHD maintains advantages in domestic and overseas market competition with product price, performance and quality, and is committed to becoming a lean and trusted company. An innovative enterprise and a world-renowned outdoor furniture and educational furniture brand enterprise.

KSHD warmly welcomes new and old customers at home and abroad to visit and cooperate with us to create brilliance together.

2008th
establish

80
country

304/316
material quality

13^w
yield

contents

BIKE RACKES

03-06



BENCHES

07-12 34



FENCES

13-14



BOLLARDS

35-54



LITTER BINS

15-33





KSZ005/6/7

Specifications

- Assembled bike rack with capacity for 4 bikes.
- Engineered for street furniture.
- Manufactured by tubular-struct. red steel.
- Available in hot dipped galvanized or electro galvanizing finish.
- Colors can be customized, such as hot dip galvanizing primary color, black, orange or others.
- Disassembly/delivery package method.

- silver
KSZ005
- orange
KSZ006
- black
KSZ007



ITEM NO.	L	W	H
KSZ005/6/7	954mm	251mm	267/190mm





KSZ001

Specifications

- Assembled bike rack with capacity for 5 bikes.
- Engineered for street furniture.
- Manufactured by tubular structured steel.
- Available in hot-dipped galvanized or electro-galvanizing finish.
- Disassembly delivery package method.

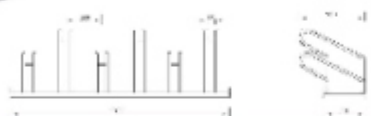

ITEM NO.	L	W	H
KSZ001	394 mm	320 mm	281 mm



KSZ002

Specifications

- Assembled bike rack with capacity for 5 bikes.
- Engineered for street furniture.
- Manufactured by tubular structured steel.
- Available in hot-dipped galvanized or electro-galvanizing finish.
- Disassembly delivery package method.

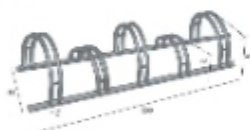

ITEM NO.	L	W	H
KSZ002	2000 mm	560 mm	490 mm



KSZ003

Specifications

- Assembled bike rack with capacity for 4 bikes.
- Engineered for street furniture.
- Manufactured by tubular structured steel.
- Available in hot-dipped galvanized or electro-galvanizing finish.
- Disassembly delivery package method.



ITEM NO.	L	W	H
KSZ003	1000 mm	320 mm	200 mm



KSZ004

Specifications

- Assembled bike rack with capacity for 4 bikes.
- Engineered for street furniture.
- Manufactured by tubular structured steel.
- Available in hot-dipped galvanized or electro-galvanizing finish.
- Disassembly delivery package method.



ITEM NO.	L	W	H
KSZ004	394 mm	320 mm	281 mm



KSZ008

Specifications

- Assembled bike rack with capacity for 2 bikes.
- Engineered for street furniture.
- Manufactured by tubular structured steel.
- Available in hot-dipped galvanized or electro-galvanizing finish.
- Colors can be customized. Such as hot dip galvanizing primary color, black, orange or others.
- Disassembly delivery package method.



- silver KSZ008
- orange KSZ009
- black KSZ010

ITEM NO.	L	W	H
KSZ008	450 mm	250 mm	281 / 190 mm



The size and color can be customized

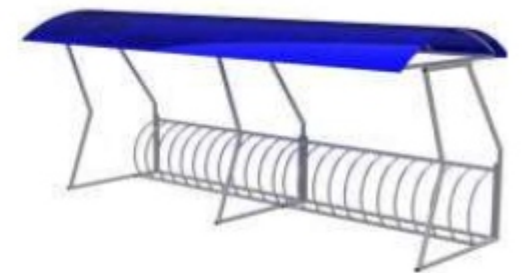



KSC003

Specifications

- Bench with hand rest.
- Finished in Black forging paint with zinc plate.
- Equipped semi-assembled in kit format.



ITEM NO.	L	W	H
KSC003	1800mm	690mm	810mm

KSC004

Specifications

- Bench with iron feet.
- Finished in black forging paint with martele.
- Supplied semi-assembled, in kit format.

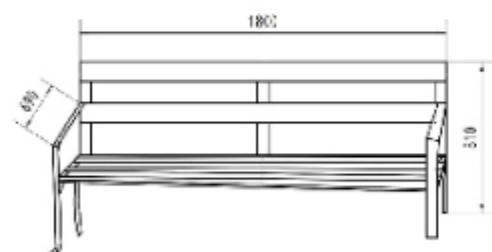

ITEM NO.	L	W	H
KSC004	1800mm	690mm	510mm

KSC005

Specifications

- Bench with iron feet.
- Finished in black forging paint with martele.
- Supplied semi-assembled, in kit format.

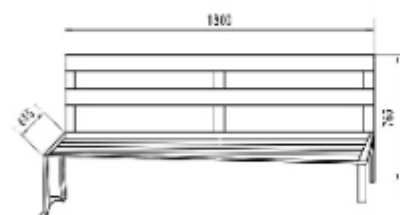

ITEM NO.	L	W	H
KSC005	1300mm	610mm	430mm

KSC006

Specifications

- Bench with iron feet.
- Finished in black forging paint with martele.
- Supplied semi-assembled, in kit format.
- No cracks, no splinters, no rot and no drying. Moisture resistant. High resistance to hard weather conditions, long-lasting and strong.



ITEM NO.	L	W	H
KSC006	600mm	690mm	430mm

KSC007

Specifications

- Bench with iron feet.
- Finished in black forging paint with martele.
- Supplied semi-assembled, in kit format.
- No cracks, no splinters, no rot and no drying. Moisture resistant. High resistance to hard weather conditions, long-lasting and strong.



ITEM NO.	L	W	H
KSC007	600mm	610mm	430mm

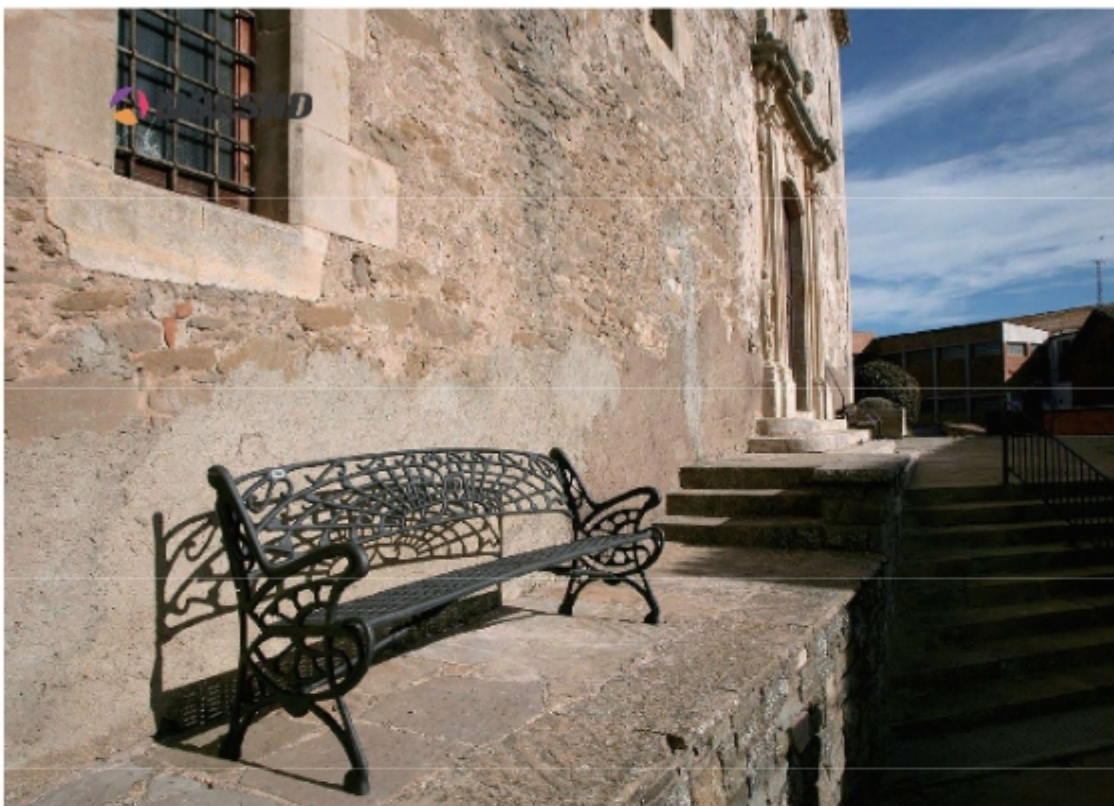

KSC008



KSC001



KSC008

Specifications

- Metal bench with iron casting structure.
- Finished in black forging paint.
- Ergonomic design specially designed for user comfort.
- Incorporates arm rests for easy use by older people.
- Disassemble and ship to save container space.

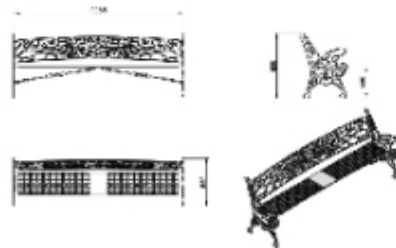

ITEM NO.	L	W	H
KSC008	2100mm	500mm	500mm

ITEM NO.	L	W	H
KSC001	1400mm	500mm	850mm

WPC Picnic Table and Chairs





KSZL001

Specifications

- Colored metal fence, four colors.
- Engineered for park and street furniture.
- Zinc-plated and baked steel with polyester paint.
- Available posts at 90° and 180°.
- Disassemble or assembled and ship to save container space.



ITEM NO.	L	H
KSZL001	2294mm	920mm
KSZL002	920mm	920mm
ITEM NO.	Ø	H
KSZL004	132mm	305mm
KSZL005	132mm	305mm
KSZL006	132mm	305mm
KSZL007	132mm	400mm



KSZL004/5/6/7

Specifications

- Post leg of colored metal fence.
- Engineered for park and street furniture.
- Zinc-plated and baked steel with polyester paint.
- Available posts at 90° and 180°.
- Disassemble or assembled and ship to save container space.



KSZL003

Specifications

- Steel Color fence Door, including central body and two legs with round base.
- Engineered for park and street furniture.
- Electronic galvanize & Powder coating.
- Disassemble or assembled and ship to save container space.

ITEM NO.	L	W	H
KSZL003	1150mm	7020mm	920mm

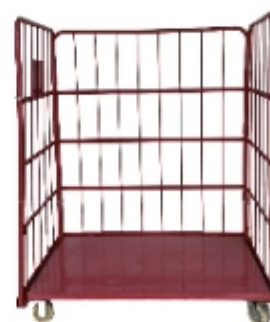

KSW001

Specifications

- Warehouse transport cart.
- Manufactured by galvanized steel.
- Stainless steel supported.
- Available in different colors of galvanized steel with powder coating.

ITEM NO.	L	W	H
KSW001	1530mm	590mm	1700mm

KSL002

Specifications

- Cor-tical inox 304 stainless steel structured bin
- Engineered for street furniture.
- Manufactured in perforated and mirror polished stainless steel.
- Body in mirror polished stainless steel.
- Customized size and color supported
- Disassemble and ship to save container space



ITEM NO.	CY	øTOP	øBTM	H BIN	H
KSL002	60L	370mm	320mm	500mm	855mm

KSL003

Specifications

- Cor-tical all perforated metal structured bin
- Engineered for street furniture.
- Manufactured in perforated and painted steel.
- Body in electrolytic galvanized steel.
- Disassemble and ship to save container's space.



ITEM NO.	CY	øTOP	øBTM	H BIN	H
KSL003	60L	370mm	320mm	500mm	855mm



KSL004/5/KSL033

Specifications

- Cor-tical best perforated metal structured bin
- Engineered for street furniture.
- Manufactured in perforated and powder coating steel.
- Body in galvanized steel, NOX001 306 supplied.
- Customized color supplied, grey, red, purple, blue, yellow, etc.
- Customized size supplied.
- Disassemble and ship to save container space.



KSL004/5

KSL033

● yellow

● purple

● blue

● red



ITEM NO.	CY	øTOP	øBTM	H BIN	H
KSL004	60L	370mm	320mm	500mm	855mm
KSL005	40L	370mm	320mm	400mm	855mm
KSL033	40L	370mm	320mm	400mm	855mm



KSL006

Specifications

- Conical metal structured bin
- Engineered for street furniture.
- Manufactured in powder coating steel.
- Body in electrolytic galvanized steel.
- Customized capacity and color could be manufactured.
- Disassemble and ship to save container space.

ITEM NO.	CY.	φ BIN	H BIN	H
KSL006	60L	370mm	480mm	860mm

KSL007/8/9

Specifications

- Cylindrical part perforated metal structured bin
- Engineered for street furniture.
- Manufactured in perforated and powder coating steel.
- Body in galvanized steel.
- Customized color - supplied Gray,red,purple,blue,yell-
low,etc.
- Customized size supported.
- Disassemble and ship to save container space.



ITEM NO.	CY.	φ BIN	W	H BIN	H
KSL007	70L	419mm	533mm	540mm	890mm
KSL008	60L	380mm	470mm	530mm	890mm
KSL009	40L	250mm	490mm	440mm	824mm

KSL010

Specifications

- Semi-cylindrical part perforated metal structured bin
- Engineered for street furniture.
- Manufactured in perforated and powder coating steel.
- Body in galvanized steel.
- Customized color - supplied Gray,red,purple,blue,yell-
low,etc.
- Customized size supported.
- Package:one unit/carton box.

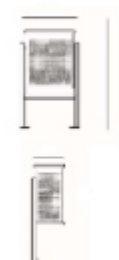

ITEM NO.	φ BIN	H BIN	H
KSL010	450mm	540mm	900mm

KSL012

Specifications

- Semi-conical part perforated metal structured bin
- Engineered for street furniture.
- Manufactured in perforated and powder coating steel.
- Body in galvanized steel with two parts perforated.
- Customized color - supplied Gray,red,purple,blue,yell-
low,etc.
- Customized size supported.
- Package:one unit/carton box.



ITEM NO.	φ BIN TOP/BTM)	H BIN	H
KSL012	420/360mm	510mm	850mm

KSL011

Specifications

- Semi-cylindrical all perforated stainless steel structured bin
- Engineered for street furniture.
- Manufactured in perforated and stainless steel.
- Body in stainless steel.
- Customized size supported.
- Package:one unit/carton box.



ITEM NO.	φ BIN	H BIN	H
KSL011	502mm	592mm	900mm

KSL013

Specifications

- Semi-conical part perforated stainless steel structured bin
- Engineered for street furniture.
- Manufactured in perforated and stainless steel.
- Body in stainless steel with two parts perforated.
- Customized size supported.
- Package:one unit/carton box.

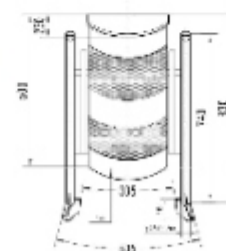

ITEM NO.	φ BIN TOP/BTM)	H BIN	H
KSL013	420/360mm	510mm	850mm



KSL020/21

Specifications

- Includes with cover and with key slot bin.
- Engineered for street furniture.
- Manufactured in perforated and painted steel.
- The ferrus treatment consists of three layers applied after shot cleaning: all impurities; an electrolytic bath; an epoxy coating and a large black polyester paint coating.
- Body in galvanized steel.
- Customized color supported.

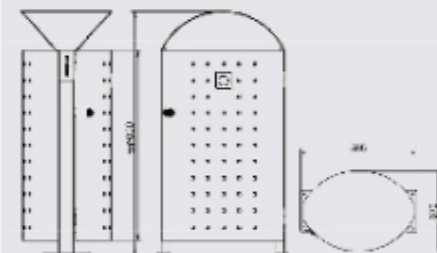

ITEM NO.	W	H	H[body]
KSL020	530mm	1020mm	780mm
KSL021	550mm	1279mm	1045mm

KSL001

Specifications

- Circular metal structured bin
- Engineered for street furniture.
- Manufactured in perforated and painted steel.
- Body in electrolytic powder coating steel.
- Possibility of color customization.

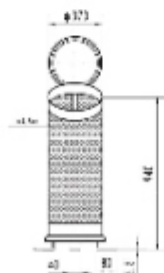

ITEM NO.	CY.	ø	H
KSL001	100L	375mm	910mm

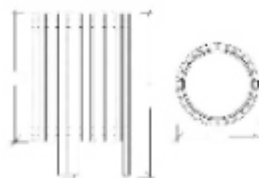

KSL015

Specifications

- Wooden three-legged landing filter bin
- Engineered for outdoor furniture.
- Manufactured in wood slat installed, with steel inner bin.

ITEM NO.	ø	H	ø (body)	H (body)
KSL015	410 mm	705 (700) mm	360mm	150mm

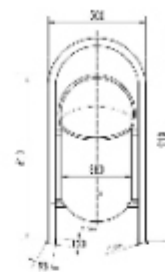

KSL022

Specifications

- Capsule structured bin
- Engineered for street furniture.
- Manufactured in galvanized steel.
- Customized size and color supported.

ITEM NO.	ø	ø BIN	H BIN	H
KSL022	500mm	350mm	510mm	510mm

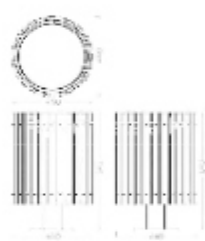

KSL028

Specifications

- Wood filter bin with steel inner bin.
- Engineered for outdoor furniture.
- Manufactured in wood slat installed, with steel inner bin.
- Customized size supported.

ITEM NO.	ø	H	H BIN
KSL028	410 mm	750mm	450mm

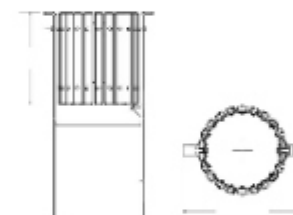

KSL029

Specifications

- shelf wood high filter bin
- Engineered for outdoor furniture.
- Manufactured in wood slat installed, with steel inner bin.

ITEM NO.	ø	H	W
KSL029	420mm	950mm	540mm

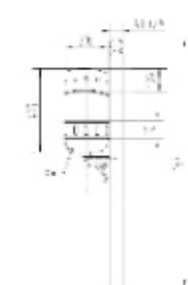

KSL016

Specifications

- Circular metal structured bin.
- Engineered for street furniture.
- Manufactured in perforated and painted steel.
- epoxy primer and polyester paint, black enamel forged in the oven.
- Body in galvanized steel.

ITEM NO.	W	ø	H	H (body)
KSL016	400 mm	310 mm	1150 mm	500 mm

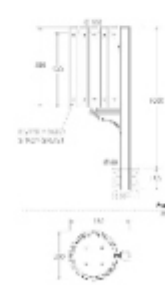

KSL027

Specifications

- Side steel post wood high filter bin
- Engineered for outdoor furniture.
- Manufactured in wood slat installed, with steel inner bin.
- Customized size supported.

ITEM NO.	ø	H	H (body)	H (wood)
KSL027	300mm	1000mm	500mm	570mm

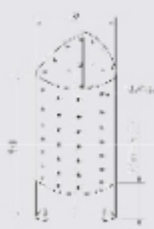

KSL014

Specifications

- Reinforced galvanized steel with laser-cut square holes.
- engineered for street furniture.
- Manufactured in laser-cut square holes and powder spraying steel.
- body in electrolytic galvanized steel.
- Customized size and color supported.

ITEM NO.
KSL014

L
380mm

H BIN
410mm

H
410mm



KSL023

Specifications

- Double-sided ashtray.
- Engineered for outdoor furniture.
- body in galvanized steel.
- Stainless steel inner grille for ash filtration.
- Contains an inner bucket for easy emptying ash/induces backdoors.

ITEM NO.
KSL023

W
120mm

H
980mm

H BIN
410mm

KSL019

Specifications

- Top open structured bin
- Engineered for street furniture
- Manufactured in steel plate.
- The outer structure use galvanizing process.
- Customized size and color supported.

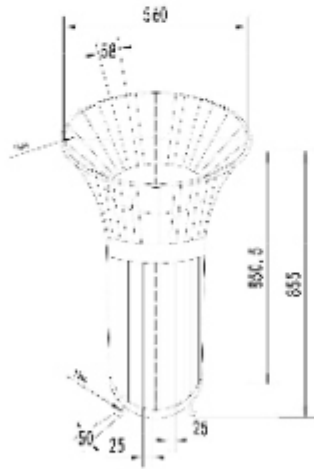

ITEM NO.	øBIN TOP/BTM	øTOP/BTM	H BIN	H
KSL019	147/290	650-130 mm	570mm	850 mm





KSL036

Specifications

- Litter bin with open top.
- Engineered for street furniture.
- Manufactured in steel plate and powder coating size.
- Body in galvanized steel.
- Customized size and color supported.

ITEM NO.
KSL036

W
170mm

H
400mm



KSL024

Specifications

- Stainless steel shake lid litter bin
- Indoor or outdoor
- Material of 201 steel for indoor usage.
- Customized size and material.

ITEM NO.
KSL024

Ø
100mm

H
500mm



KSL017

Specifications

- Top open structured bin
- Engineered for street furniture.
- Manufactured in steel plate.
- Hot dip galvanizing.
- Customized size supported.

ITEM NO.
KSL017

Ø
74mm

H
90mm

Ø (body)
50mm

H (body)
70mm



KSL025

Specifications

- Stainless steel shake lid and front open litter bin
- Indoor or outdoor
- Material of 201 steel for indoor usage.
- Customized size and material.

ITEM NO.
KSL025

Ø
100mm

H
500mm



KSL018

Specifications

- Top open structured bin
- Engineered for street furniture.
- Manufactured in steel plate.
- Hot dip galvanizing.
- Customized size supported.

ITEM NO.
KSL018

Ø
74mm

H
67mm

Ø (body)
45mm

H (body)
70mm



KSL026

Specifications

- Stainless steel top ashtray litter bin
- Indoor or outdoor
- Material of 201 steel for indoor usage.
- Customized size and material.

ITEM NO.
KSL026

Ø
100mm

H
700mm



KSL035

Specifications

- Litter bin with top lid and ashtray.
- Engineered for street furniture.
- Manufactured in steel plate and powder coating steel.
- Body in galvanized steel.
- Customized size supplied.

ITEM NO.
KSL035

Ø
400mm

H
1100mm

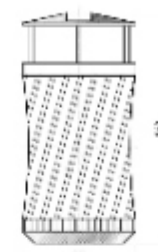

KSL031

Specifications

- Litter bin with top lid, ashtray, with steel inner bin.
- Engineered for street furniture.
- Manufactured in steel plate and powder coating steel.
- Body in galvanized steel. UNOX304 306 could be supplied.
- Customized color supplied.
- Customized size supplied.

ITEM NO.
KSL031

Ø
475mm

H
960mm

Ø(body)
300mm

H(body)
640mm



KSL037

Specifications

- Litter bin with open top.
- Engineered for street furniture.
- Manufactured in steel plate and powder coating steel.
- Body in galvanized steel.
- Customized size and color supported.

ITEM NO.
KSL037

Ø
510mm

H
700mm



KSL032

Specifications

- Litter bin with steel inner bin
- Engineered for park and street furniture.
- The top cover is formed at one time, which can effectively prevent rain and water from falling
- Manufactured in galvanized and painted steel.
- Customized color supplied.
- Customized size supplied.

ITEM NO.
KSL032

L
490mm

W
360mm

H
850mm

L(body)
290mm

W(body)
280mm

H(body)
490mm

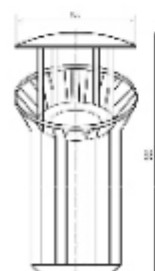

KSL030

Specifications

- Litter bin with top lid, with steel inner bin
- Engineered for street furniture.
- Manufactured in steel plate and powder coating steel.
- Body in galvanized steel. UNOX304 306 could be supplied.
- Customized color supplied.
- Customized size supplied.

ITEM NO.
KSL030

Ø(body)
330mm

H(body)
730mm

Ø
400mm

H
920mm



KSL034

Specifications

- Litter bin with top lid and ashtray.
- Engineered for street furniture.
- Manufactured in steel plate and powder coating steel.
- Body in galvanized steel.
- Customized size supplied.

ITEM NO.
KSL034

Ø
480mm

H
920mm

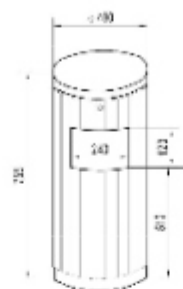
KSL042

ITEM NO.
KSL042

Ø

400mm

H

715mm

KSL038



ITEM NO.
KSL038

W

545mm

H

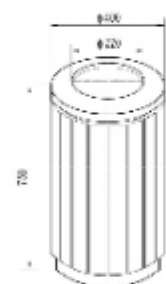
555mm

KSL044

ITEM NO.
KSL044

Ø

400mm

H

710mm

KSL039



ITEM NO.
KSL039

W

410mm

H

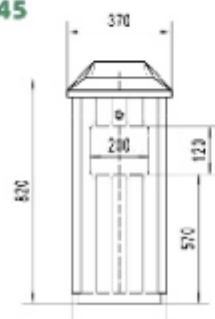
410mm

KSL045

ITEM NO.
KSL045

W

370mm

H

830mm

KSL040

ITEM NO.
KSL040

W

355mm

H

1200mm



KSL041

ITEM NO.
KSL041

W
420mm

H
1520mm



KSC009

ITEM NO.
KSC009

W
900mm

H
900mm

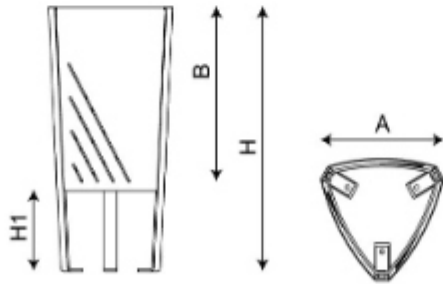
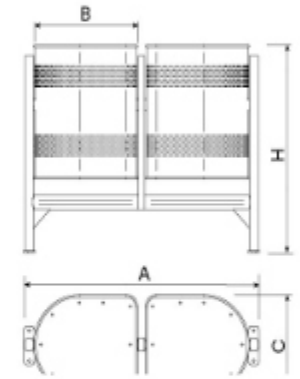
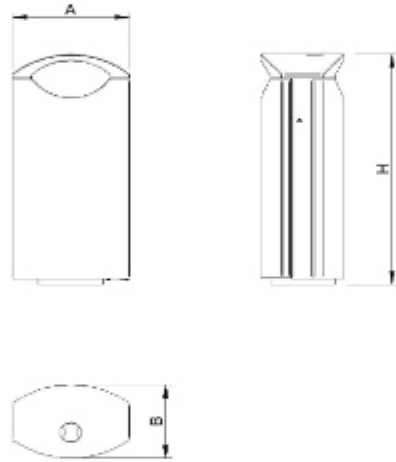
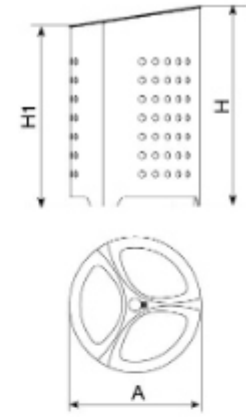
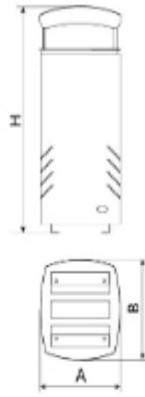

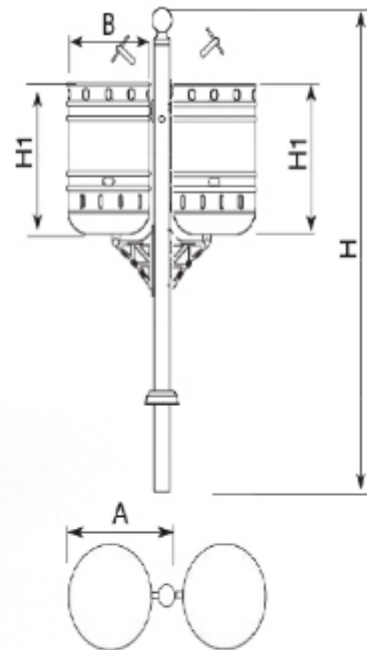
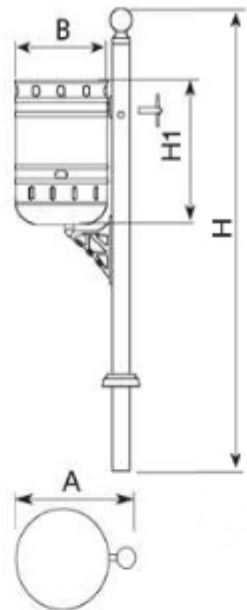

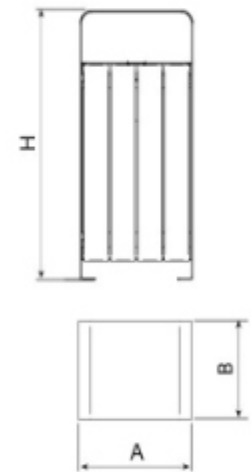
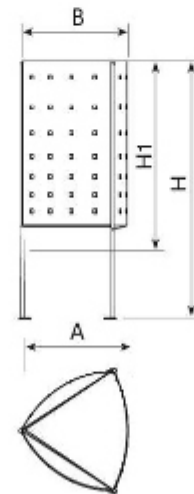
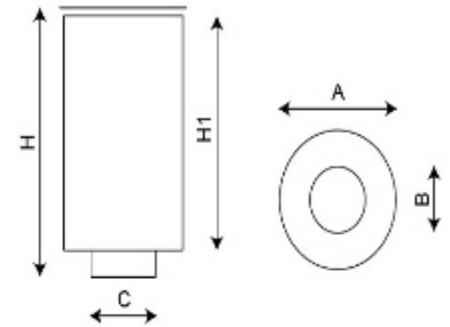
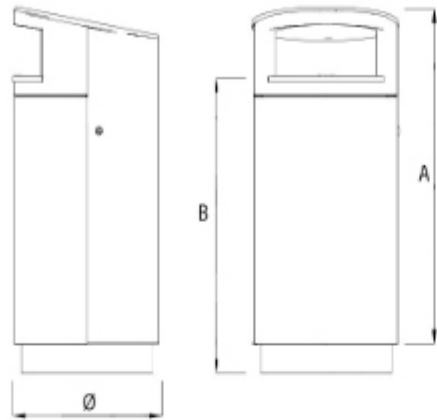



Professional Factory, Support Customization.



Supports Customization





DT-3

款式 分类垃圾桶

颜色 银亮色

尺寸 138*36*76cm

说明 可定制LOGO





Customizable Trash Bins

Color, Size, Logo...









KSLU011

Specifications

- Bollard made of steel.
- This treatment with galvanized.
- Recommended anchoring: embedded base and threaded rods with concrete.

ITEM NO.
KSLU011

W
300mm

H
110mm



KSLU014

Specifications

- Separating bollard made of zinc-plated and baked steel with polyester paint.
- It could be used to separate green areas, like parks, etc.
- Definitely our bollards make public places more aesthetic.

ITEM NO.
KSLU014

top
100mm

middle
270mm

bottom
100mm

H
110mm

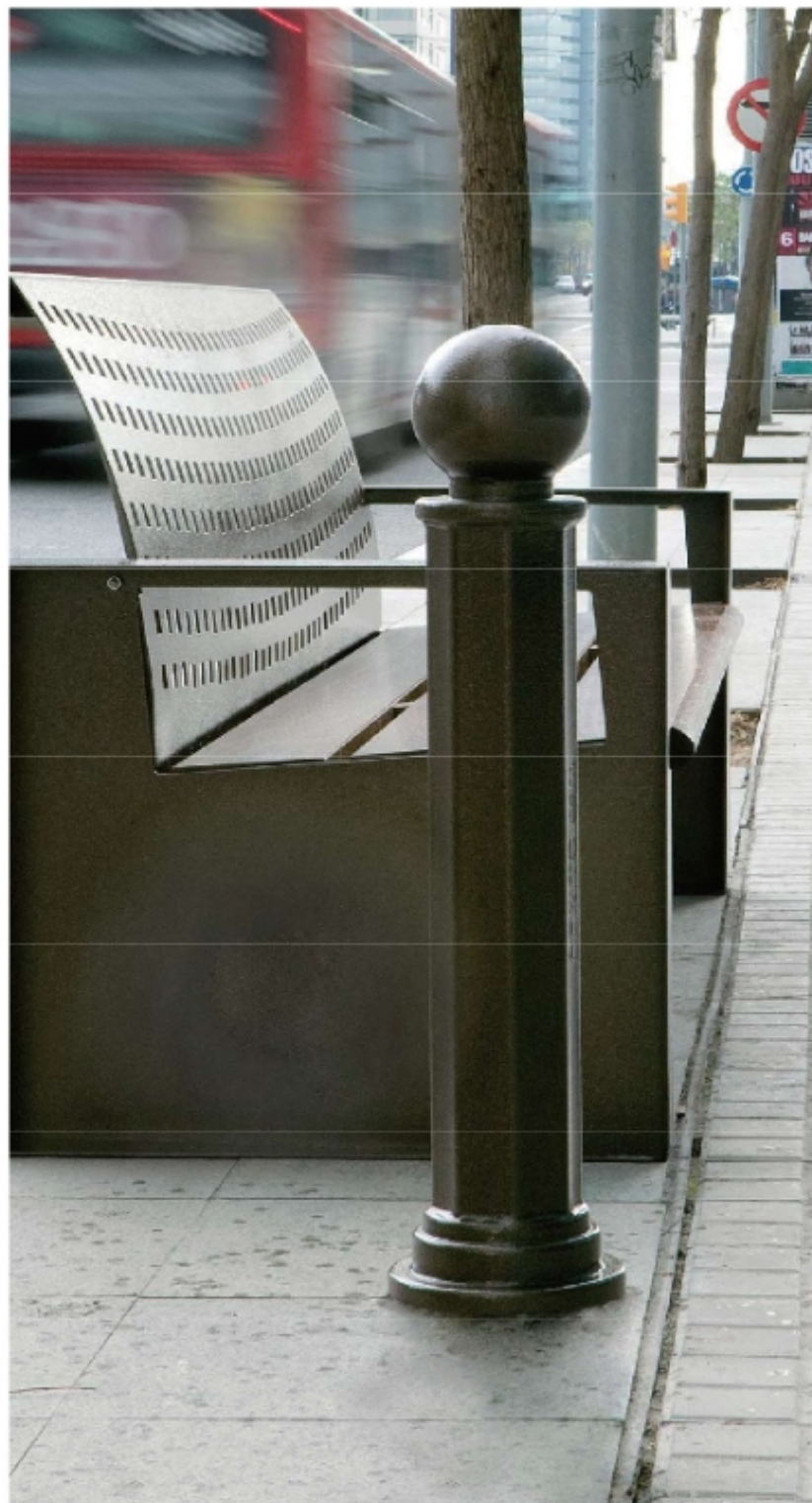

KSLU012

Specifications

- Separating bollard made of zinc plated, epoxy primer coating and black RAL 9005 polyester powder coating.
- It could be used to separate green areas, like parks, etc.
- Definitely our bollards make public places more aesthetic.

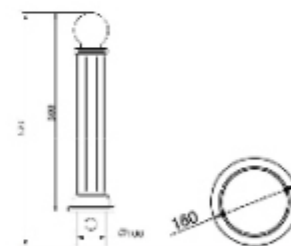

ITEM NO.

W

H

KSLU012

100mm

670mm

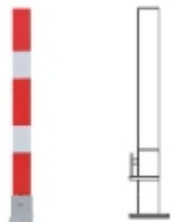

KSLU001

Specifications

- Separating bollard made of zinc-plated and baked steel with polyester paint.
- It could be used in separate green areas, like parks, alleys.
- Definitely our bollards make public places more aesthetic.

ITEM NO.
KSLU001

W
720mm

H
990mm



KSLU002

Specifications

- Separating bollard made of zinc-plated and baked steel with polyester paint.
- Coating for added protection.
- Dot on anti-rain specification.
- Root fixed for strong foundation.
- Available in a range of RAL colour options.
- It could be used to separate green areas, like parks, alleys.
- Definitely our bollards make public places more aesthetic.

ITEM NO.
KSLU002

W
700mm

H
990mm

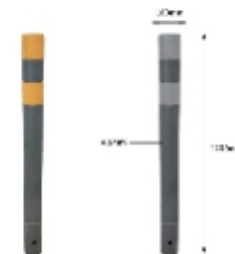

KSLU003

Specifications

- Galvanized steel bollard KSL003/7 from BSHD have become an essential part of modern architecture.
- They are used for a variety of purposes, ranging from traffic control to safety and security.
- These bollards are made of hot-dipped galvanized steel, which provides excellent durability and ensures that they can withstand harsh weather conditions.
- There are various models of galvanized steel bollards available in the marketplace, some of which are yellow and grey in color.

ITEM NO.
KSLU003

Ø
100mm

H
1200mm



KSLU010

Specifications

- Separating bollard made of Zinc-plated and baked steel with polyester paint.
- Coating for added protection
- Optional anti-ram specification
- Root fixed for strong foundation
- It could be used to separate green areas, like parks, alleys.
- Definitely our bollards make public places more aesthetic.

ITEM NO.
KSLU010

Ø
210mm

H
600mm



KSLU005

Specifications

- Separating bollard made of Zinc-plated and baked steel with polyester paint.
- Coating for added protection
- Optional anti-ram specification
- Root fixed for strong foundation
- Available in a range of RAL colour options.
- It could be used to separate green areas, like parks, alleys.
- Definitely our bollards make public places more aesthetic.

ITEM NO.
KSLU005

Ø
90mm

H
1000mm



KSLU006

Specifications

- Its design is simple and functional and stands out thanks to the stainless steel ring which adds a distinctive touch to this sober bollard made of iron.
- Bollard made of steel.
- This treatment with galvanized.
- Recommended anchoring: embedded base and flanged end rods with concrete.

ITEM NO.
KSLU006

L
95mm

H
1000mm



KSLU007

Specifications

- Anchor to be ground by the same inner rod and cement.
- Possibility of customization by including shield and manufacture in different colors.
- Ideal for delimiting public areas, planning spaces and adapting to the accessibility conditions.

ITEM NO.
KSLU007

Ø
100mm

H
1000mm



KSLU008

Specifications

- Base finish in galvanized.
- Root fixed for strong foundation
- It could be used to separate green areas, like parks, alleys.
- Definitely our bollards make public places more aesthetic.

ITEM NO.
KSLU008

W
50mm

H
1070mm



KSLU013

Specifications

- Separating bollard made of Zinc-plated and baked steel with polyester paint.
- It could be used to separate green areas, like parks, alleys.
- Definitely our bollards make public places more aesthetic.

ITEM NO.
KSLU013

Ø
76mm

H
1000mm

KSLU042-49

Specifications

Sturdy and Durable: The bollard post is made of a combination of thickened stainless steel and surface polishing with weld grinding process. It is durable, not easy to rust, and has the greatest strength, durability, and resistance to oxidation, UV rays, and harsh weather conditions.

Easy Parking: Many people use these bollard passages or driveways to mark when to stop their cars. It is convenient and quick to park.

High Visibility: The surface layer of the parking bollard is made of strong reflective sheeting, which sticks tightly and firmly. It is not easy to fade and fall off after long-term exposure. It has a long-lasting reflection and improves the driver's visibility to improve driving awareness and caution.

Multiple Uses: The traffic control pole is perfect for emergency responders, maneuverability driver training, horse courses, ramping and driveway warning signs, Cordon off areas for the parking, picnic or other public areas to prevent the car from being scratched.

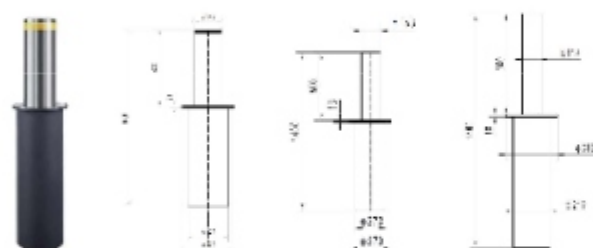

KSLU042

ITEM NO.	Ø	H	H buried underground
KSLU042	219mm	600mm	300mm
	168mm	600mm	300mm
	114mm	600mm	1700mm



KSLU043

ITEM NO.	Ø	H	H buried underground
KSLU043	219mm	316mm	600mm

KSLU045



ITEM NO.	Ø	H
KSLU045	219mm	600mm

KSLU044



ITEM NO.	Ø	H
KSLU044	219mm	600mm



KSLU046

ITEM NO.	Ø	H
KSLU046	178mm	550mm
	174mm	500mm
	159mm	500mm
	159mm	500mm
	219mm	750mm



KSLU009

Specifications

- Low profile design provides added protection from fork truck damage
- Four pre-drilled mounting holes in base plate allow quick lag down installation
- Powder coat yellow finish provides long lasting durable coverage
- Heavy-duty welded steel construction protects racks, building walls, expensive equipment, and hundreds of other applications

ITEM NO.
KSLU009

L
300

H
150

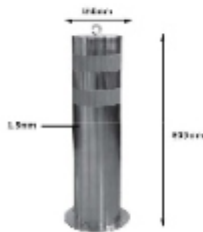

KSLU004

Specifications

- Sturdy and Durable:** The bollard post is made of a combination of thickened stainless steel and surface polishing with weld grinding process. It is durable, not easy to rust, and has the greatest strength, durability, and resistance to oxidation, UV rays, and harsh weather conditions.
- Easy Parking:** Many people use these in their garages or driveways to mark when to stop their cars. It is convenient and quick to park.
- High Visibility:** The surface layer of the parking bollard is made of strong reflective sheeting, which sticks tightly and firmly. It is not easy to fade and fall off after long term exposure. It has a long-lasting reflection and improves the driver's visibility to improve driving awareness and caution.
- Multiple Uses:** The traffic control pole is perfect for emergency responders, maneuverability driver training, horse courses, camping and driveway warning signs. Cordon off areas for the parking lot, side or other public areas to prevent the car from being scratched.

ITEM NO.
KSLU004

D
100mm

H
600mm





KSLU047

Specifications

- The car bollard's locking arm features reflective tape that allows for visibility in low light or at night.
- The pillar and the base are separate. If parking pole blocks the road, the column part can be temporarily removed.
- The hanging ring is welded very firmly, it is easy to pass the chain through the hanging ring.
- Stainless steel Pipe Bollards protect buildings, pedestrians and equipments from vehicle or forklift collisions.
- Use for parking spaces and driveways

ITEM NO.	Ø	H
KSLU047	114mm	550mm
	114mm	500mm
	150mm	500mm



KSLU048

Specifications

- Separating bollard made of Zinc-plated and baked steel with polyester paint.
- Coating for acidic protection
- Optional anti-ram specification
- Root fixed for strong foundation
- Available in a range of RAL colour options
- It could be used to separate green areas, like parks, alleys.
- Definitely our bollards make public places more aesthetic.

ITEM NO.	Ø	H
KSLU048	150mm	550mm
	150mm	500mm



KSLU049

Specifications

- Separating bollard made of zinc plated and baked steel with polyester paint.
- Coating for acidic protection
- Optional anti-ram specification
- Root fixed for strong foundation
- Available in a range of RAL colour options
- It could be used to separate green areas, like parks, alleys.
- Definitely our bollards make public places more aesthetic.

ITEM NO.	Ø	H
KSLU049	114mm	550mm
	130mm	750mm
	150mm	750mm
	210mm	750mm

KSLU015-41

Specifications

- Separating bollard made of zinc plated and baked steel with polyester paint
- Coating for acidic protection
- Optional anti-ram specification
- Root fixed for strong foundation
- Available in a range of RAL colour options
- It could be used to separate green areas, like parks, alleys.
- Definitely our bollards make public places more aesthetic.

KSLU015-41

KSLU015

ITEM NO.	D	H
KSLU015	250 mm	1160 mm

KSLU016

ITEM NO.	D	H
KSLU016	300 mm	650 mm

KSLU017

ITEM NO.	D	H
KSLU017	300 mm	530 mm

KSLU018

ITEM NO.	D	H
KSLU018	300 mm	920 mm

KSLU019

ITEM NO.	D	H
KSLU019	300 mm	280 mm

KSLU020

ITEM NO.	D	H
KSLU020	210 mm	740 mm

KSLU021

ITEM NO.	D	H
KSLU021	300 mm	750 mm

KSLU022

ITEM NO.	D	H
KSLU022	215 mm	840 mm

KSLU023

ITEM NO.	D	H
KSLU023	150 mm	600 mm

KSLU024



ITEM NO.	Ø	H
KSLU024	175mm	970mm

KSLU025



ITEM NO.	Ø	H
KSLU025	302mm	830mm

KSLU026



ITEM NO.	Ø	H
KSLU026	300mm	750mm

KSLU027



ITEM NO.	Ø	H
KSLU027	200mm	800mm

KSLU028



ITEM NO.	Ø	H
KSLU028	80mm	250±20mm

KSLU029



ITEM NO.	Ø	H
KSLU029	300mm	1±20mm

KSLU030



ITEM NO.	Ø	H
KSLU030	100mm	240mm

KSLU031



ITEM NO.	Ø	H
KSLU031	200mm	800mm

KSLU032



ITEM NO.	Ø	H
KSLU032	200mm	900mm

KSLU033



ITEM NO.	Ø	H
KSLU033	200mm	600mm

KSLU034



ITEM NO.	Ø	H
KSLU034	120mm	1030mm

KSLU035



ITEM NO.	Ø	H
KSLU035	230mm	720mm

KSLU036



ITEM NO.	Ø	H
KSLU036	200mm	450mm

KSLU037



ITEM NO.	Ø	H
KSLU037	420mm	550mm

KSLU038



ITEM NO.	Ø	H
KSLU038	180mm	570mm

KSLU039



ITEM NO.	Ø	H
KSLU039	250mm	520mm

KSLU040



ITEM NO.	Ø	H
KSLU040	120/80mm	550mm

KSLU041



ITEM NO.	Ø	H
KSLU041	300mm	1200mm

